

GS-4000 SERIES

Ultra Performance CNC Turning Centers

GOODWAY MACHINE CORP.

MAXIMUM PERFORMANCE CNC TURNING CENTERS

For those seeking a heavy-duty maximum performance turning center that's packed with the latest technologies, GOODWAY's GS-4000 series is the perfect solution. These machines offer awesome turning power, 37 Kw (30 min.) 2-speed gear-head spindles are standard on most models (excluding GS-4033), to easily turn work pieces up to 24" diameter, and to accommodate various work piece lengths, 4 bed sizes offering maximum tuning lengths ranging from 750 ~ 3,000 mm are available. Live tooling, Y-axis and sub-spindle models further increase machining efficiency and accuracy, while reducing man power. Furthermore, GOODWAY machines are always fully loaded with standard features that are either not available or costly options found on other machines. Features such as chip conveyor, programmable base tailstock, turning tool holders are standard plus many more.

- ▶ Under the covers, you'll find a 30 degrees slant bed with super wide box ways, and GS-4000 & GS-4300 series equipped with an enormous 2-speed head stock driven by a 37 Kw (30 min.) Fanuc motor.
- ▶ Extra large Z-axis spindle motors provide the thrust needed to efficiently drill big diameter holes.
- ▶ Axes rapids are 24 m/min. on X and Z, which are 50 ~100 % faster than the competition.*1

*1 Individual models may vary, please see P.17.



GS-4000 series machines feature a standard programmable base and quill tailstock.



- ▶ Manual mode quill-jog function allows the quill to be inched forward, which makes it easier to insert the center into the center hole.
- ▶ Movement of the base and quill in auto mode are controlled by M-codes and thrust pressure is manually adjustable.
- ▶ Z-axis carriage automatically locks onto the tailstock base and moves it to the desired position with precision accuracy.

- ▶ 4 bed lengths and 3 spindle sizes offer a total of 12 basic model configurations.

SERIES	GS-4033 SERIES	GS-4000 SERIES	GS-4300 SERIES
Chuck Size	Ø 12"	Ø 15" (18")	Ø 24"
Bar Capacity	Ø 90 mm (3.5")	Ø 115 mm (4.5")	Ø 165 mm (6.5")
Turning Length*2	750 mm (29.5")	GS-4000 / M / Y / S / MS / YS	GS-4300 / M / Y / S / MS / YS
	1,500 mm (59")	GS-4033L / LM / LY / LS / LMS / LYS	GS-4300L / LM / LY / LS / LMS / LYS
	2,250 mm (88.5")	GS-4033L ² / L ² M / L ² Y / L ² S / L ² MS / L ² YS	GS-4300L ² / L ² M / L ² Y / L ² S / L ² MS / L ² YS
	3,000 mm (118.1")	GS-4033L ³ / L ³ M / L ³ Y	GS-4300L ³ / L ³ M / L ³ Y

「M」 model for optional live tooling turret function. Detail Specification please see Page 6 & 18.

「Y」 model for optional Y-axis function. Detail Specification please see Page 7 & 18.

「S」 model for optional sub-spindle function. Detail Specification please see Page 8 & 18.

*2 Individual models may vary, detail Specification please see work range diagram.



(GS-4000L³ model shown with optional accessories)

Machine rigidity is increased by eliminating the opening required for under-machine-type coolant tanks.

- ▶ Utilizing unused space, this coolant tank placement allows optimal air circulation for faster heat dispersion and lower coolant temperature, which will help extend coolant life.
- ▶ Coolant tank allows the connection of compressed air to circulate coolant and keep it fresh when machine is not in use.
- ▶ Less space limitations allow larger 670 L coolant tank capacity and easier maintenance access.



Separate coolant tank & Oil skimmer shown.

SUPER HEAVY-DUTY CONSTRUCTION

- ▶ The low center of gravity heavy-duty bed and 30° slant bed design provide a super rigid foundation for the headstock, turret, and tailstock. Creating the rigidity needed to perform super heavy-duty turning and maintaining long-term high precision accuracy. More rigidity also means extended tool life.
- ▶ Built to endure years and years of rigorous high production turning, the heavily ribbed, one-piece thermally balanced bed and casting components are of FC35-Meehanite casting (industry standard is FC25~30). FC35 grade cast iron is capable of withstanding much greater stress without deforming and provides maximum vibration damping, which result in a machine that will outlast and outperform the competition.
- ▶ By using Finite Element Methods (FEM), optimal reinforce ribbings are directly cast into the one-piece bed structure. Mechanical rigidity has been increased by more than 30% when compared to conventional designs.



- ▶ C3 class hardened and precision ground ball screws ensure the highest accuracy and durability possible. Plus, pretension on all axes minimizes thermal distortion.

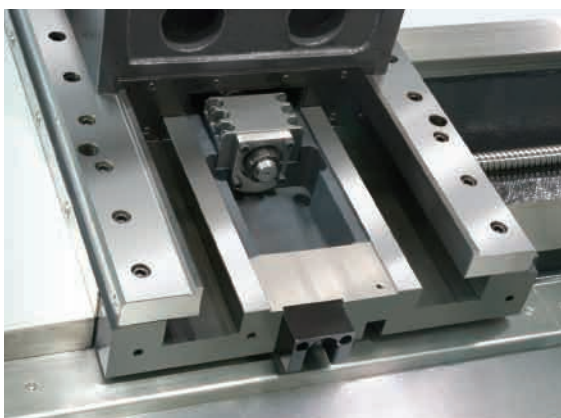

- ▶ Extra wide hardened and ground box ways are directly formed into the machine bed and saddle during the casting process. They are precision machined and widely spaced for maximum strength. The box way design also provides the rigidity needed for heavy duty and interrupted turning applications.

- ▶ The L³ series Z-axis equipped with independent supporting mechanism prevents long-sized ball screws from deforming and ensures excellent performance for the axial feed and turning accuracy.

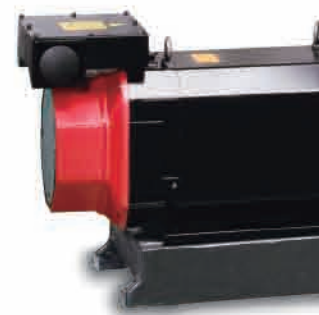

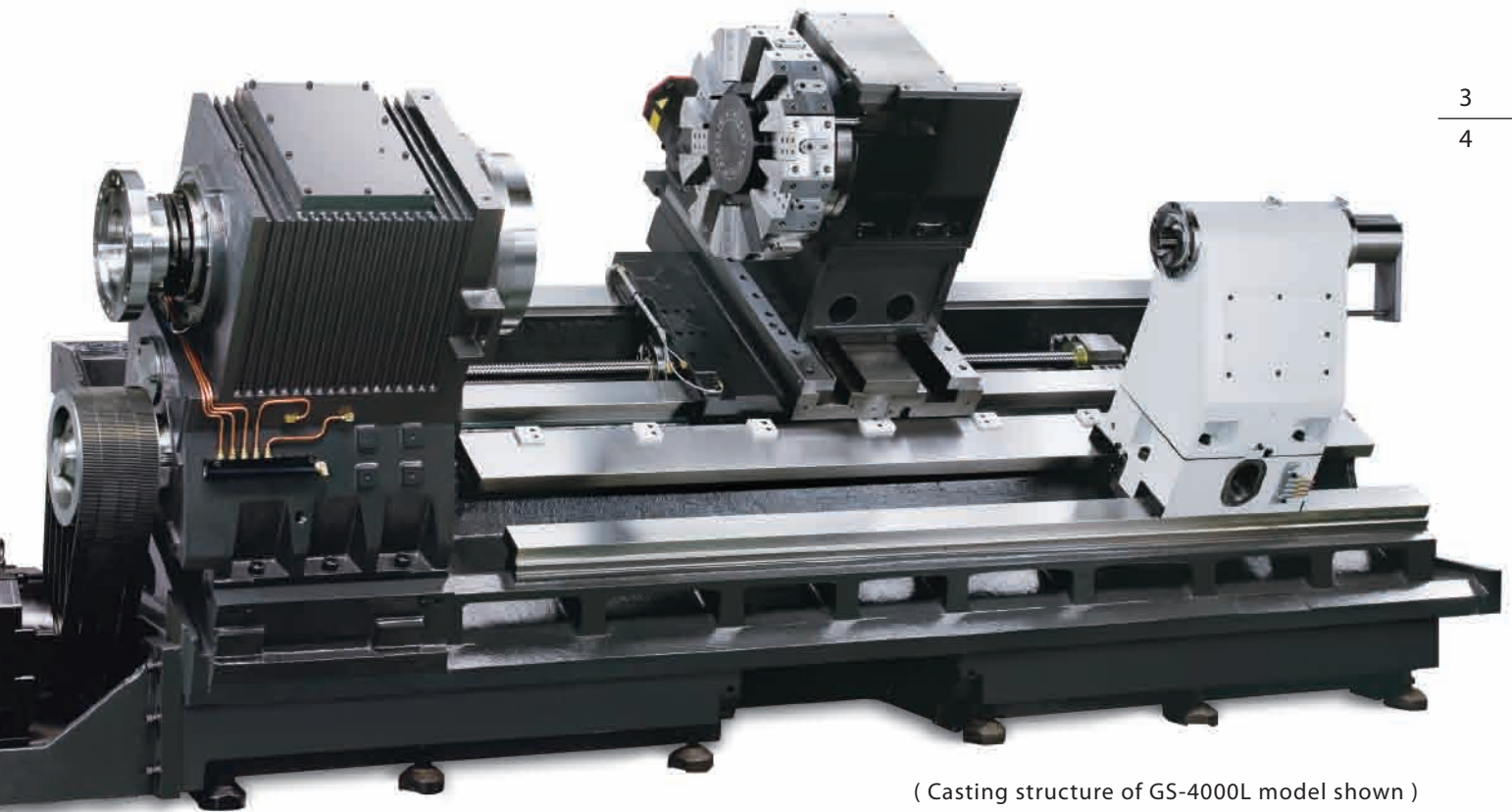

(Casting structure of GS-4000L model shown)

- ▶ All spindle and servo motors, including drives, are Fanuc alpha *i* series components to ensure peak machining performance and accuracy.
- ▶ X and Z axes are driven by over-sized Fanuc AC alpha *i* series absolute servo motors, providing tremendous thrust outputs with faster acceleration and deceleration. Absolute encoder technology eliminates the use of limit switches, thus, eliminating referencing axes to home positions and broken limit switches.

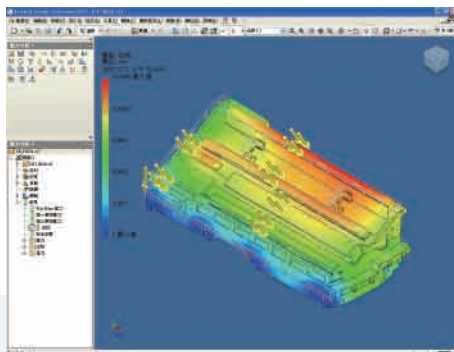

- ▶ Utilizing the latest 3D CAD design software to assist in machine development, and FEM to provide engineering analysis, we are able to create the best designs possible.

- ▶ Contact surfaces of all slides, headstock, turret, tailstock, and ball screw bearing housings with the machine bed are hand scraped to provide maximum assembly precision, structural rigidity, and load distribution.



ULTIMATE TURNING POWER

- ▶ P4 grade (Class 7) super-high precision bearings are directly assembled for maximum level of support and precision. Bearing configuration is designed for super heavy-duty cutting with ultra-smooth performance and long term durability with a higher level of accuracy.
- ▶ The heavy-duty headstock is of one-piece casting reinforced with heat dispending fins.

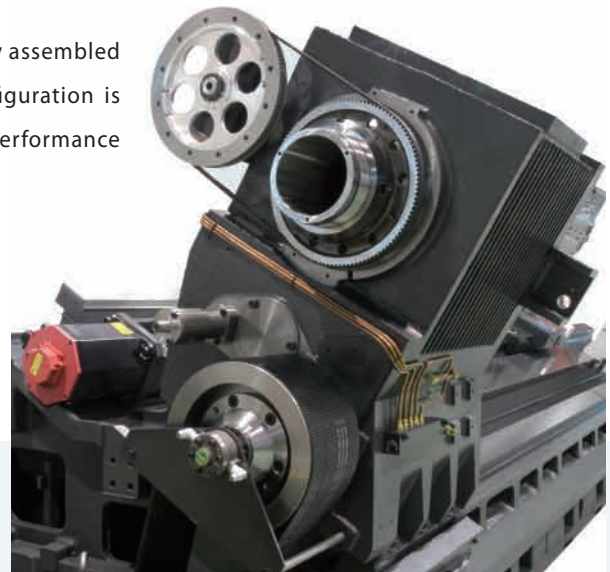

- ▶ The 2-speed super heavy duty gear head incorporates advance mechanical designs. Mated with a 37 Kw (30 min.) motor to provide tremendous amount of low-end torque to handle heavy material removal on large diameter parts.
(Standard on GS-4000 & GS-4300, option for GS-4033 series)

Spindle Output

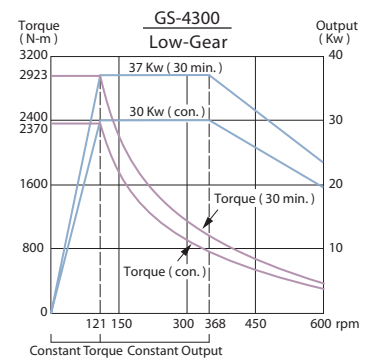
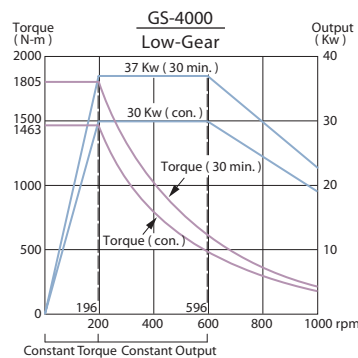
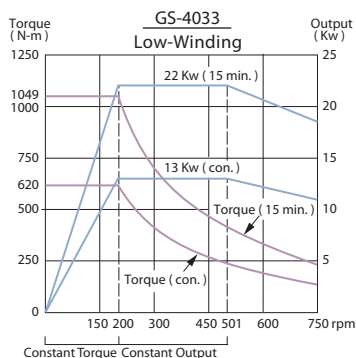
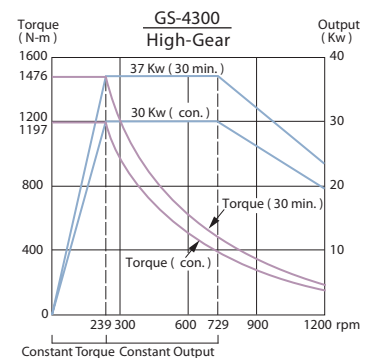
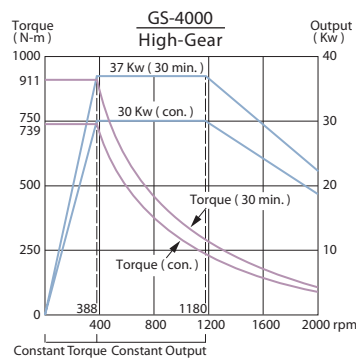
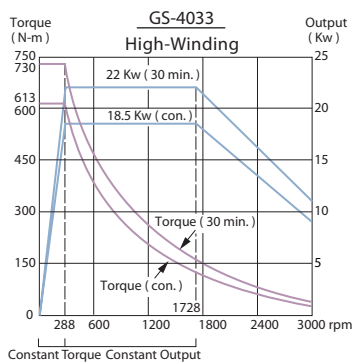

ADVANCED TURRET TECHNOLOGY

- ▶ \varnothing 320 mm diameter super high precision CURVIC couplings accurately position the turret disk and 6,400kg of clamping force ensure abundant turret rigidity for all cutting conditions.
- ▶ The 12-station heavy-duty servo indexing turret achieves 0.3 second indexing times for adjacent stations. Index movements are continuous, without pauses, and is capable of turning \varnothing 268 mm (\varnothing 10.5") diameter work pieces without interference when using boring tools. The optional 10-station turret even clears up to \varnothing 331 mm (\varnothing 13") diameter.

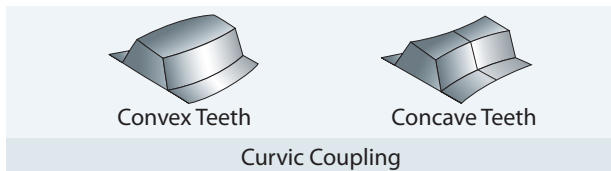

- ▶ The curvic couplings provide a large contact area and are designed with an auto-clean feature not seen on traditional couplings.

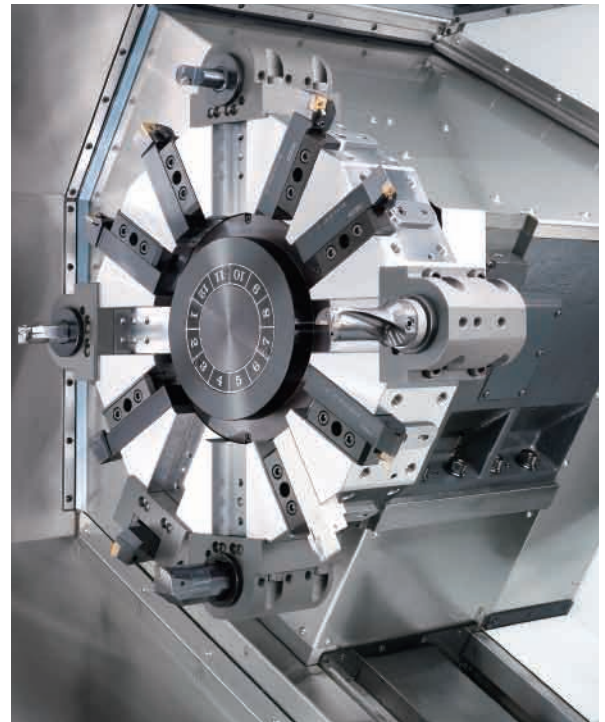

LIVE TOOLING TURRET

- ▶ Live tooling and C-axis control capabilities on the GS-4000 series allows the machine to perform multiple tasks on a work piece, such as turning, milling, drilling and tapping. It eliminates manpower and cycle time, while reducing accuracy lost, which will occur if the part is moved from machine to machine.
- ▶ The GS-4000 series live tooling turret is driven by a big power 7.5 Kw (30 min.) spindle motor and combined with gear box, it provides ultra high power to meet any difficult task in milling, drilling and tapping application.
- ▶ The 12-station GOODWAY live tooling turret offers 12 stations available for live tooling, live tools rotate in working position only to reduce power loss and heat.



- ▶ The Cs-axis is adopted with a high-resolution toroid along with a full-closed loop design, to provide excellent positioning accuracy and repeatability.

Y-AXIS MACHINING CAPABILITY

- ▶ Y-axis control further enhances multi-tasking live tooling capabilities and improves various machining precision. High precision grooving and X-axis off-center drilling are enabled.



(GS-4300Y model shown)

- ▶ With an abundant amount of Y-axis travel, 120 mm = ± 60 mm (4.72" = ± 2.36"), a wide variety of parts may be efficiently machined.
- ▶ Live tooling turret for Y-axis machine is equipped with 5.5 Kw output, high precision built-in spindle turret.

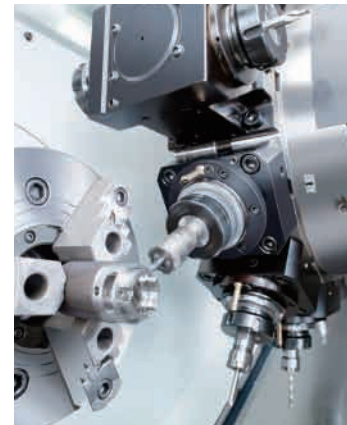

- ▶ On Y-axis equipped machines, the turret is mounted on a secondary 30 degrees wedge saddle on top of the X-axis slide. Both X & Y axes have extra wide hardened and ground box ways, which are directly formed onto the saddles during the casting process. They are precision machined and widely spaced for maximum strength.

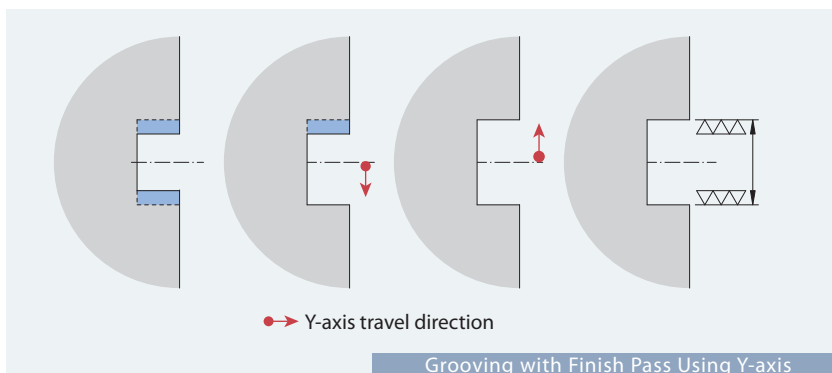
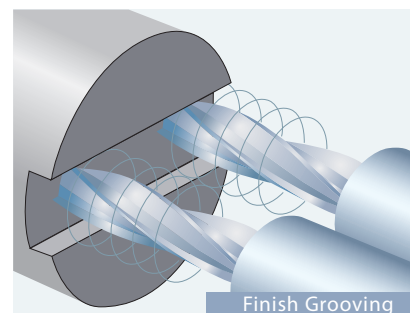
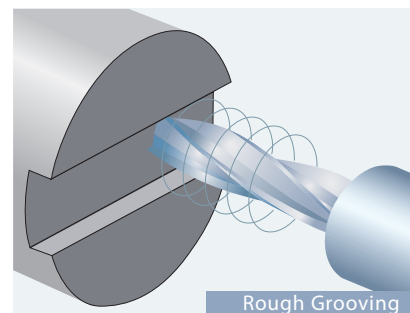
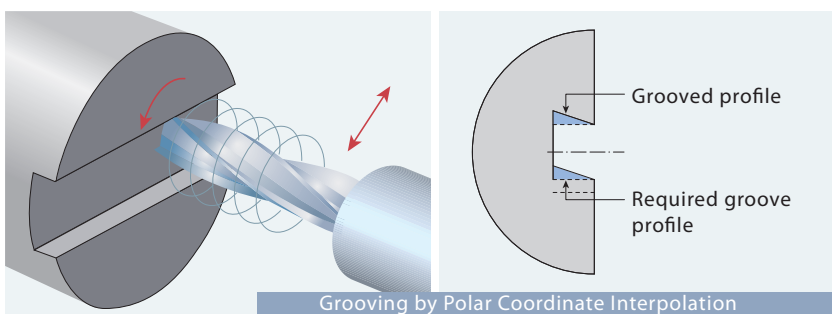

- ▶ Grooving with Y-axis control produces grooves with higher accuracy.

BACK-END MACHINING CAPABILITY

- ▶ A 8" chuck size sub-spindle driven by a powerful 21 Kw (15 min.) built-in type Fanuc motor (Integrated Motor) for back-end machining is available on the GS-4000 series.
- ▶ The sub-spindle travels on the B-axis are used with Japanese high precision roller linear guideways to increase the feed rate and reduce processing time.

Sub-spindle Output

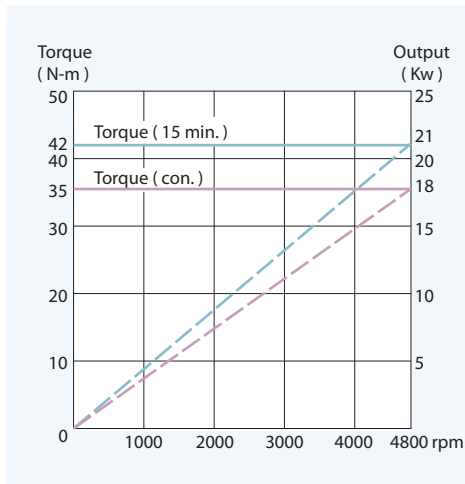

- ▶ Automatic part transfer of work piece from main spindle to sub-spindle saves manpower and cycle time, while reducing accuracy lost, which will occur if manually handling the part from machine to machine.

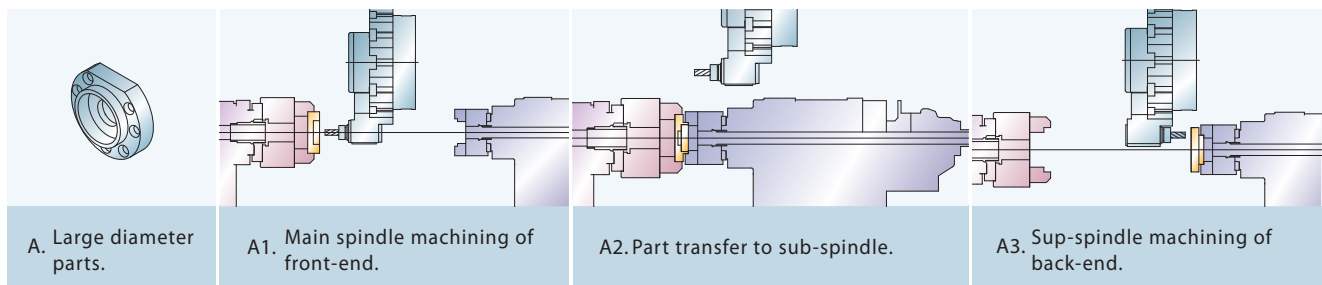

- ▶ With $\varnothing 45$ mm (1.77") bar capacity, the sub-spindle configuration is also ideal for machining long work pieces such as small diameter shafts. Both ends of the work piece can be supported by the main and sub spindles, allowing the middle section(s) to be accurately machined.

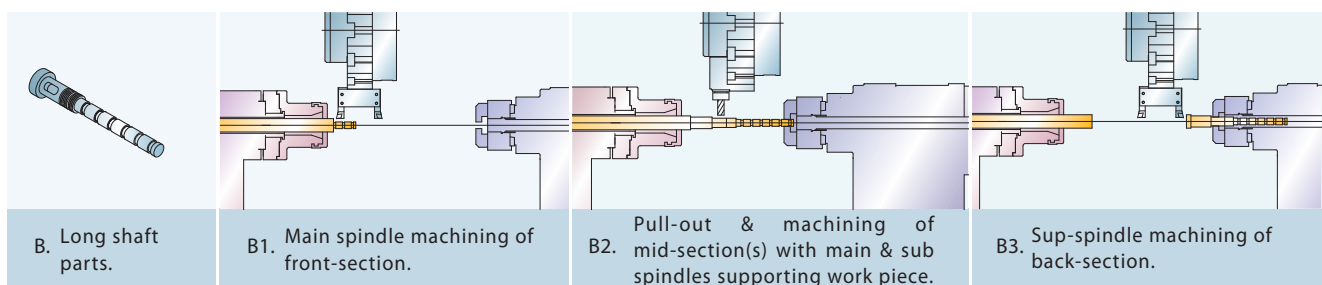

MACHINING PERFORMANCE

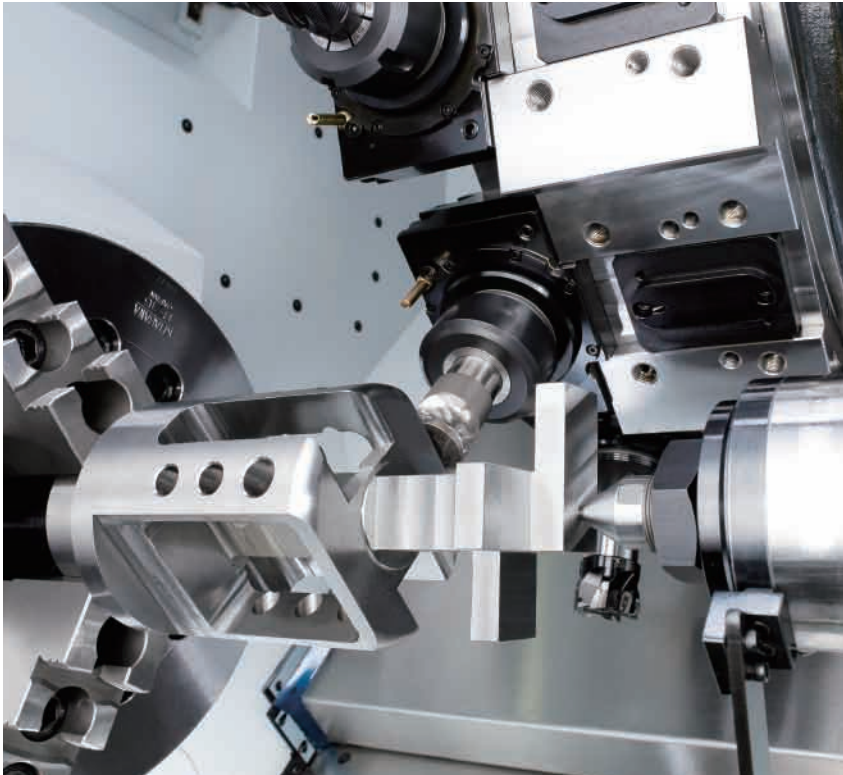

Live Tooling Turret Output

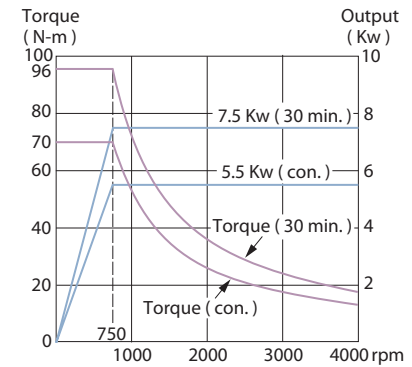

Sample Work Pieces



Turning Capability

Test Model	Workpiece		Cutting condition				Power requirement
	Material	Diameter (mm)	Spindle Speed (rpm)	Cutting Speed (m/min)	Cutting Depth (mm)	Feedrate (mm/rev)	Spindle Load (%)
Heavy Cutting	S45C	Ø 175	310	170	10	0.6	102 / 70
Drill	S45C	Ø 58	741	135	—	0.18	62 / 85

Machining Capability

Test Model	Workpiece		Cutting condition			
	Material	Diameter (mm)	Spindle Speed (rpm)	Cutting Speed (m/min)	Cutting Depth (mm)	Feedrate (mm/min)
Drill	S45C	Ø 25	249	20	—	90
End Mill	S45C	Ø 25	510	40	15	290
Tapping	S45C	M20 x P2.5	160	10	—	400

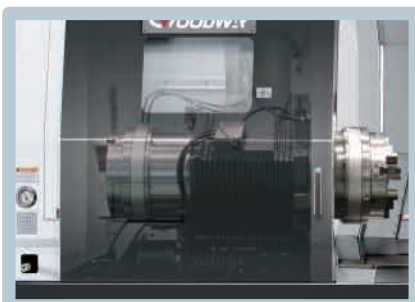

- ▶ The front-end of the spindle can be installed with a air chuck or manual chuck to easily apply operations such as thread cutting to long work pieces.



Standard 12-Stations Turret

Interference Diagram

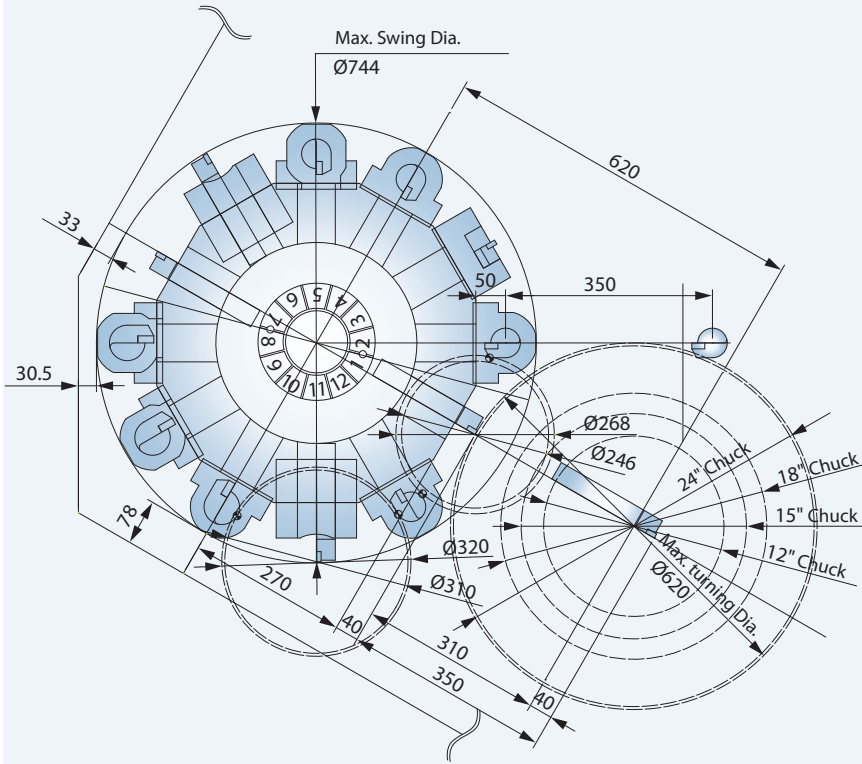

Tooling System

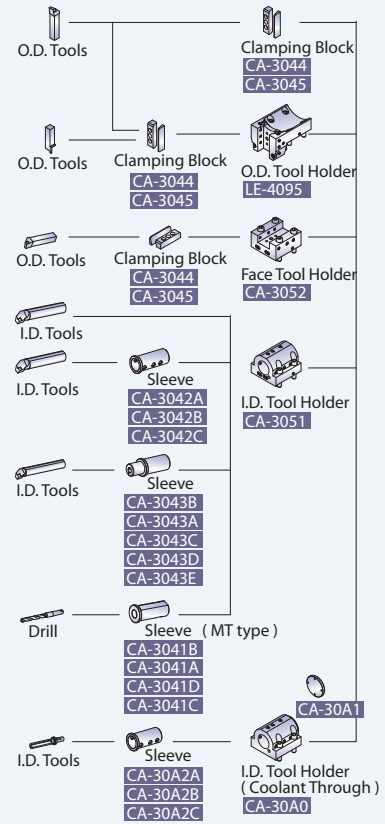

Optional 12-Stations Live Tooling Turret

Interference Diagram

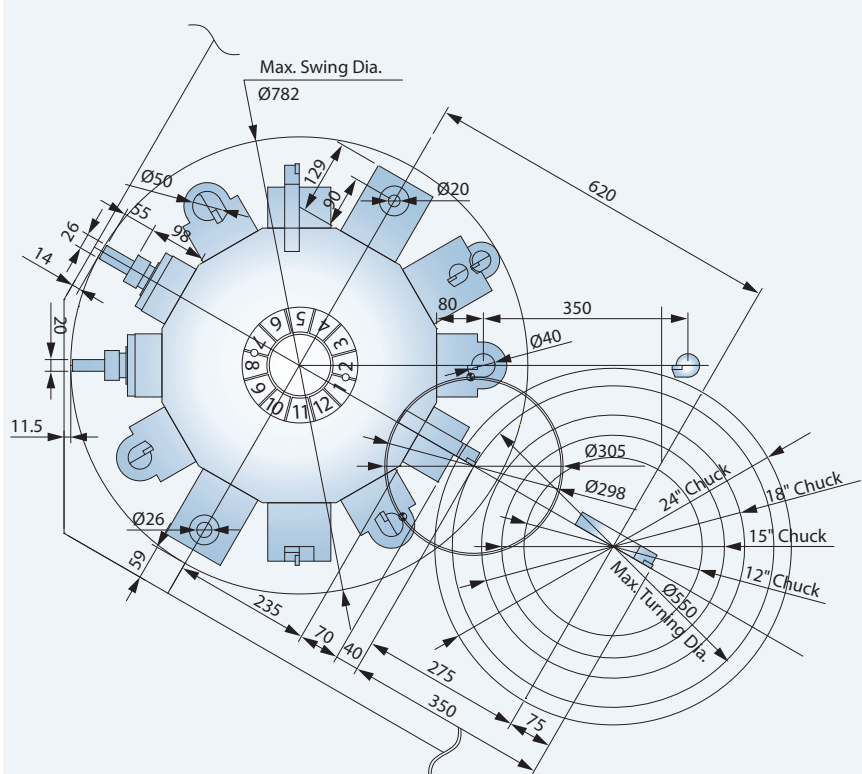

Tooling System

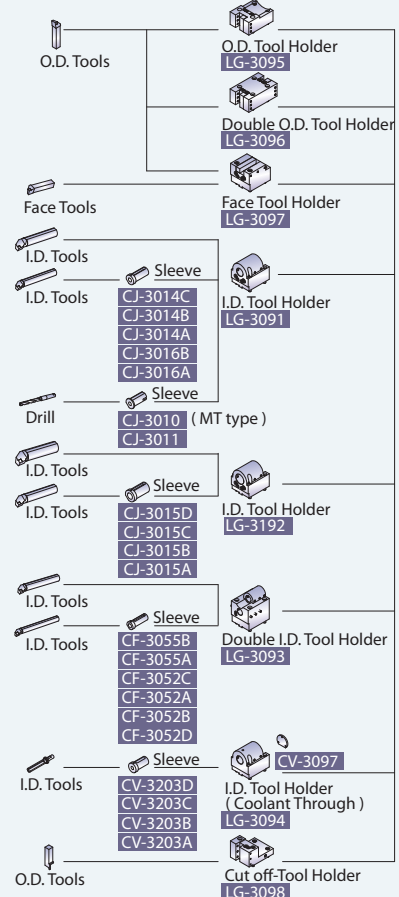

Optional Y-axis

Interference Diagram

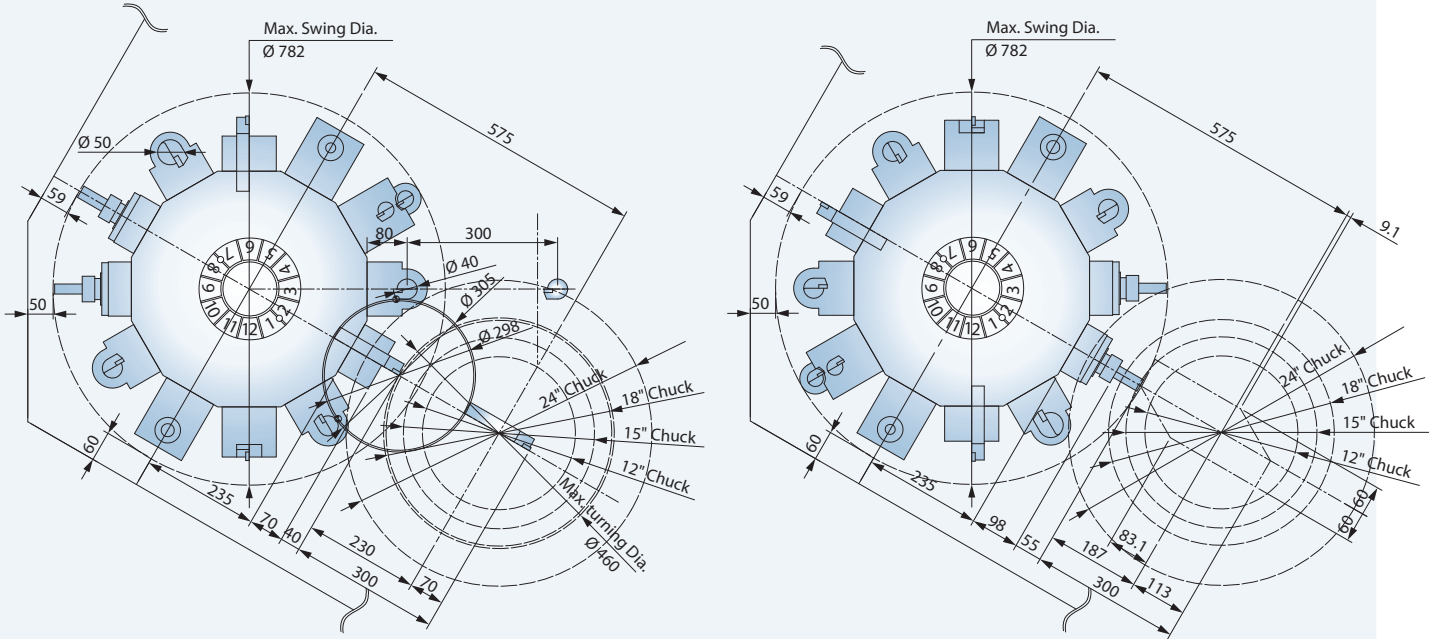

Interference Diagram

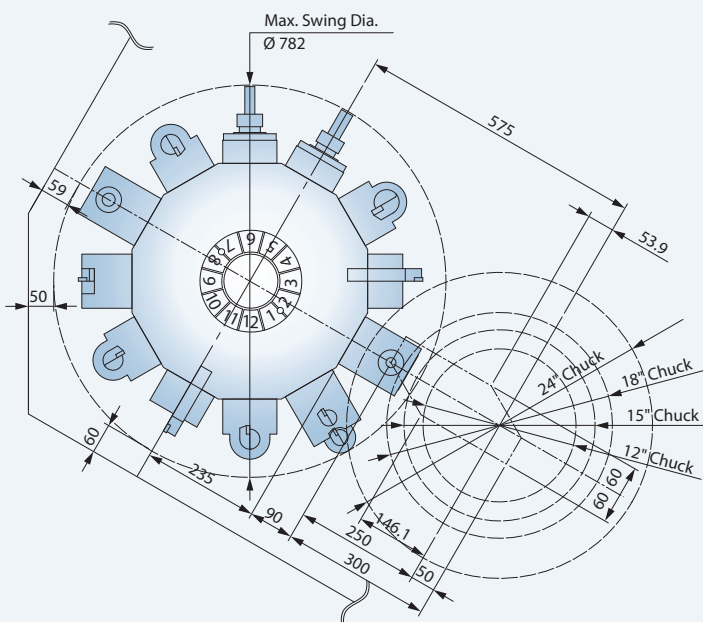

Unit : mm

Tooling System

O.D. Tools	O.D. Tool Holder LG-3095
	Double O.D. Tool Holder LG-3096
Face Tools	Face Tool Holder LG-3097
I.D. Tools	I.D. Tool Holder LG-3091
I.D. Tools	
Drill	CJ-3010 (MT type) CJ-3011
I.D. Tools	I.D. Tool Holder LG-3192
I.D. Tools	
I.D. Tools	
I.D. Tools	
I.D. Tools	Double I.D. Tool Holder LG-3093
I.D. Tools	
I.D. Tools	
I.D. Tools	
I.D. Tools	
I.D. Tools	
I.D. Tools	I.D. Tool Holder (Coolant Through) LG-3094
I.D. Tools	
I.D. Tools	
I.D. Tools	
O.D. Tools	Cut off-Tool Holder LG-3098

Standard 12-Stations Turret

【 Work Range 】

MT#6
Live Center

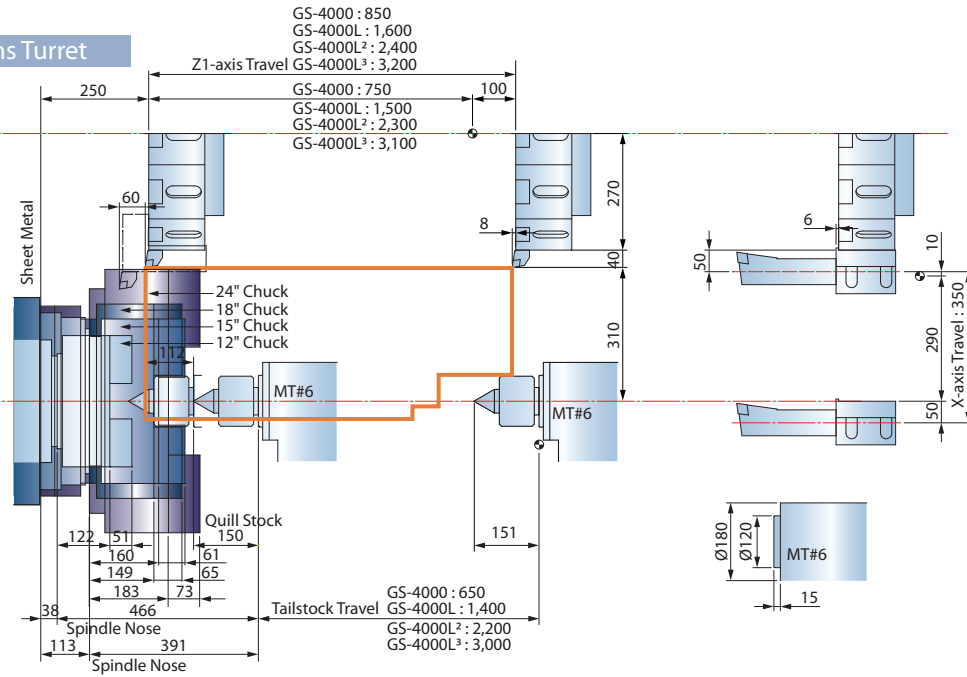

11
12

Optional Live Tooling Turret

【 Work Range 】

MT#6
Live Center
(I.D. / O.D. Tools)

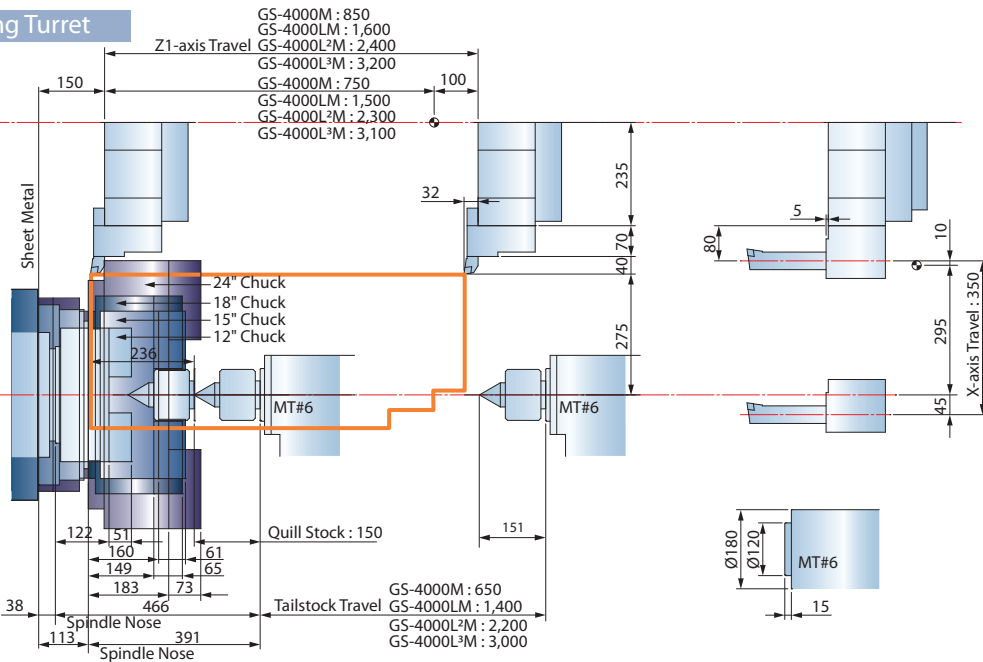

MT#6
Live Center
(Live Tooling)

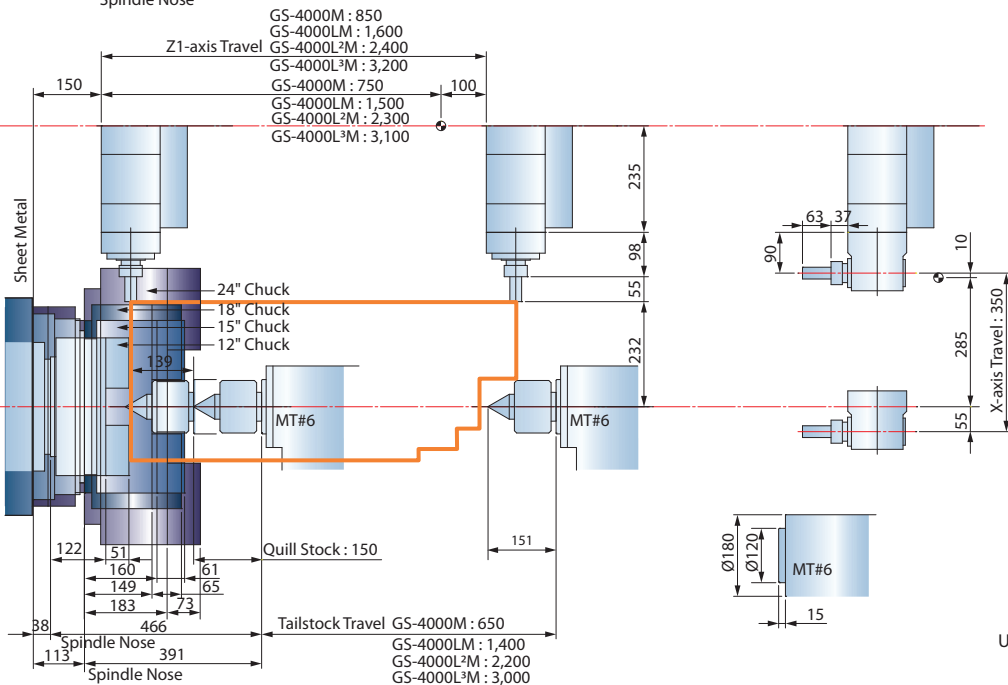

Unit : mm

Optional Live Tooling Turret & Sub-spindle

[Work Range]

(I.D. / O.D. Tools)

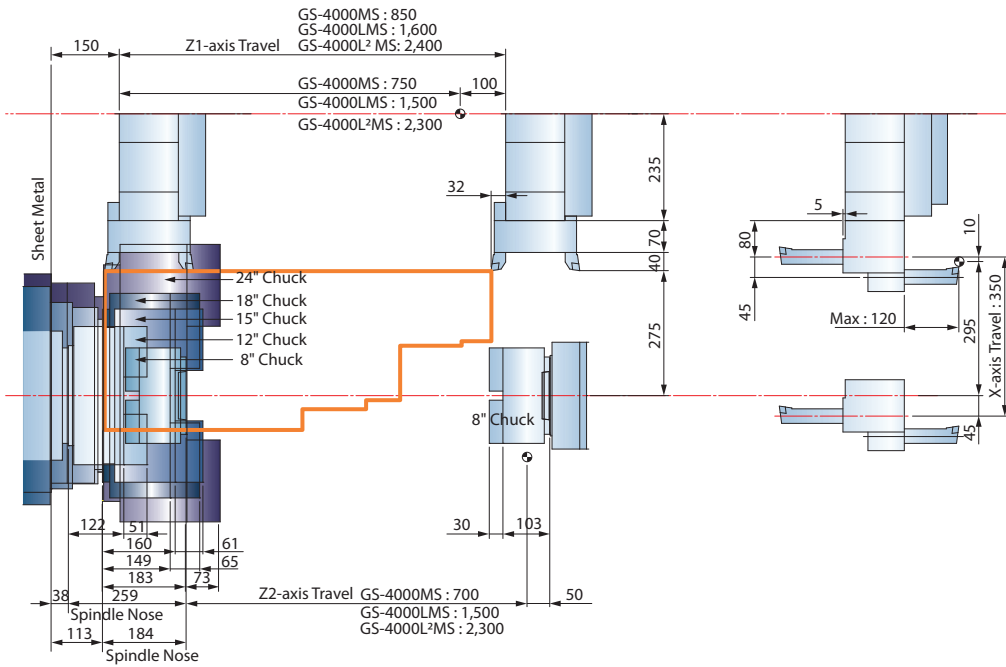

(Live Tooling)

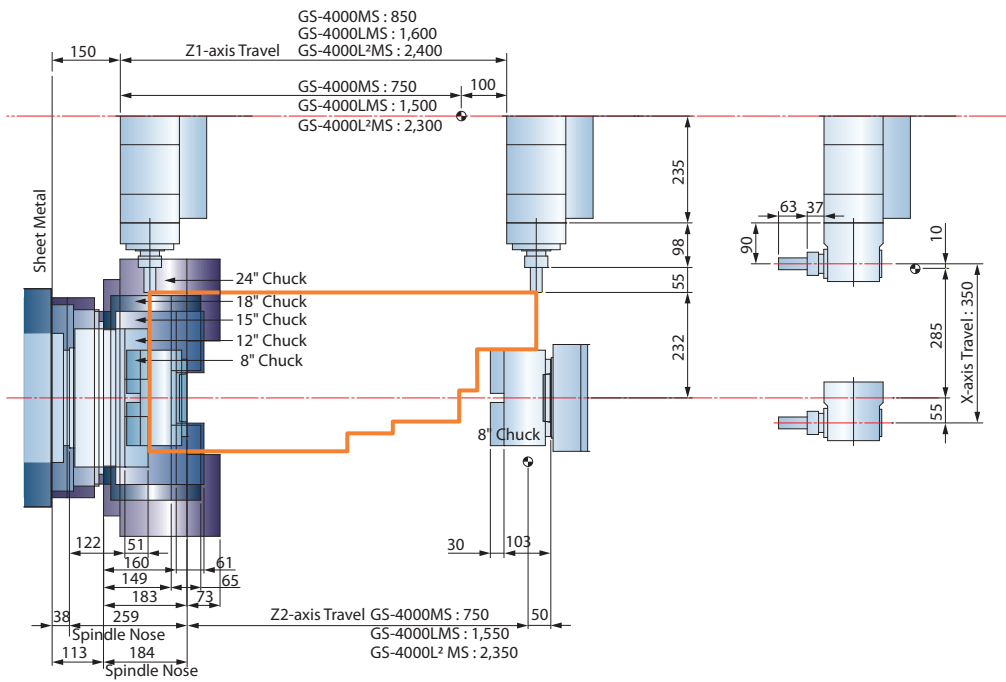

Optional Y-axis

[Work Range]

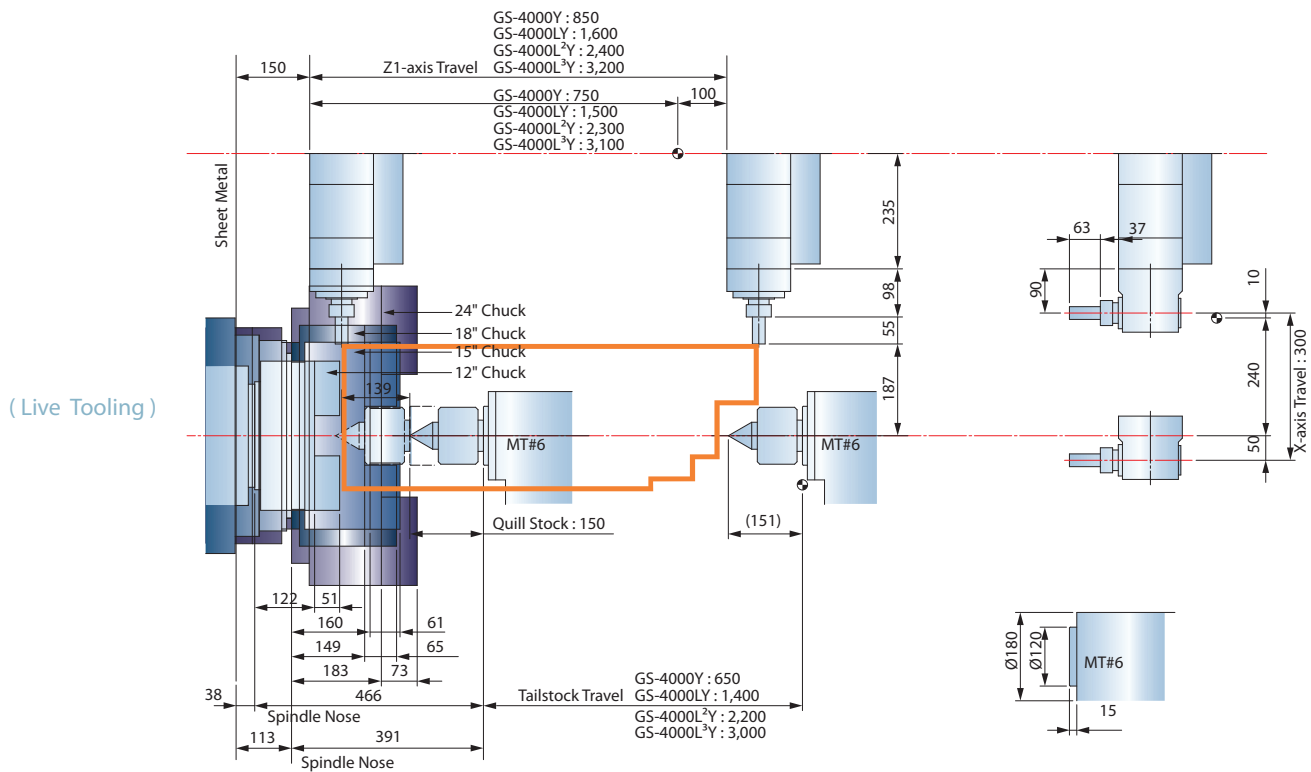
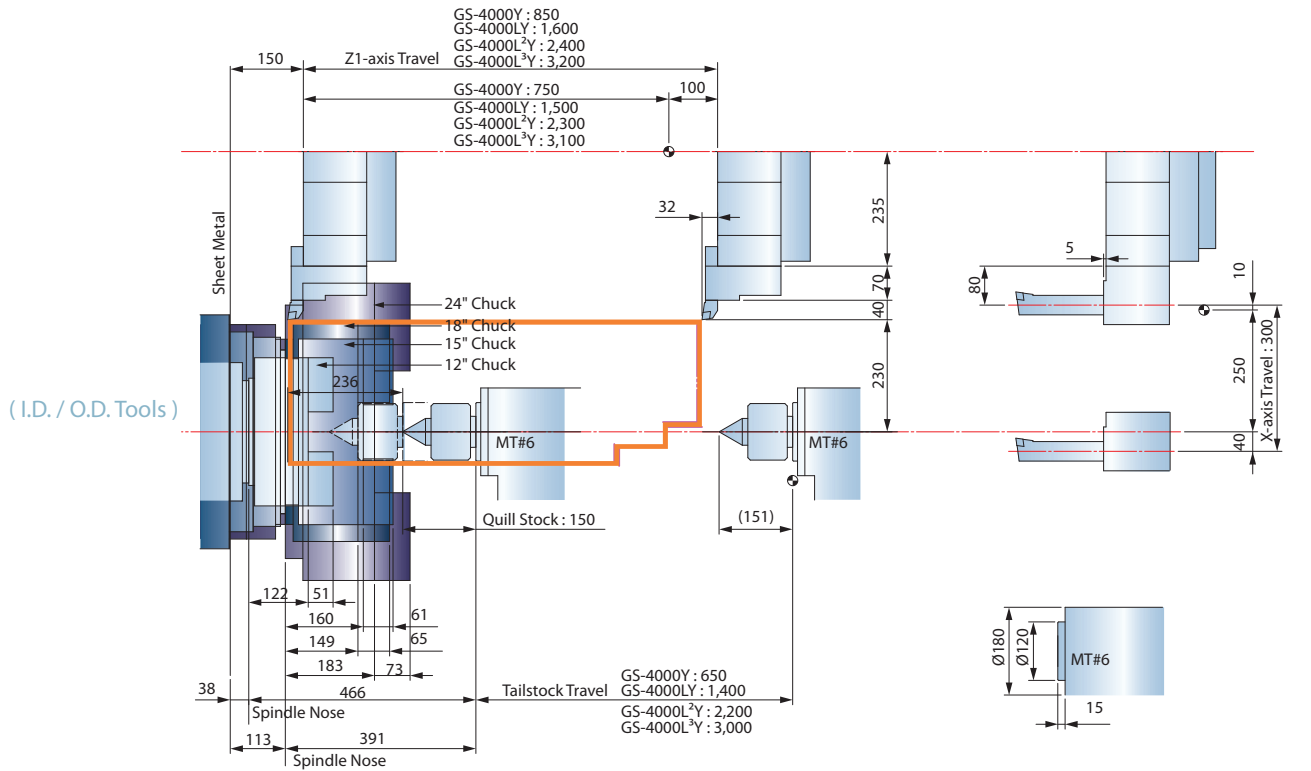

Optional Y-axis & Sub-spindle

[Work Range]

(I.D. / O.D. Tools)

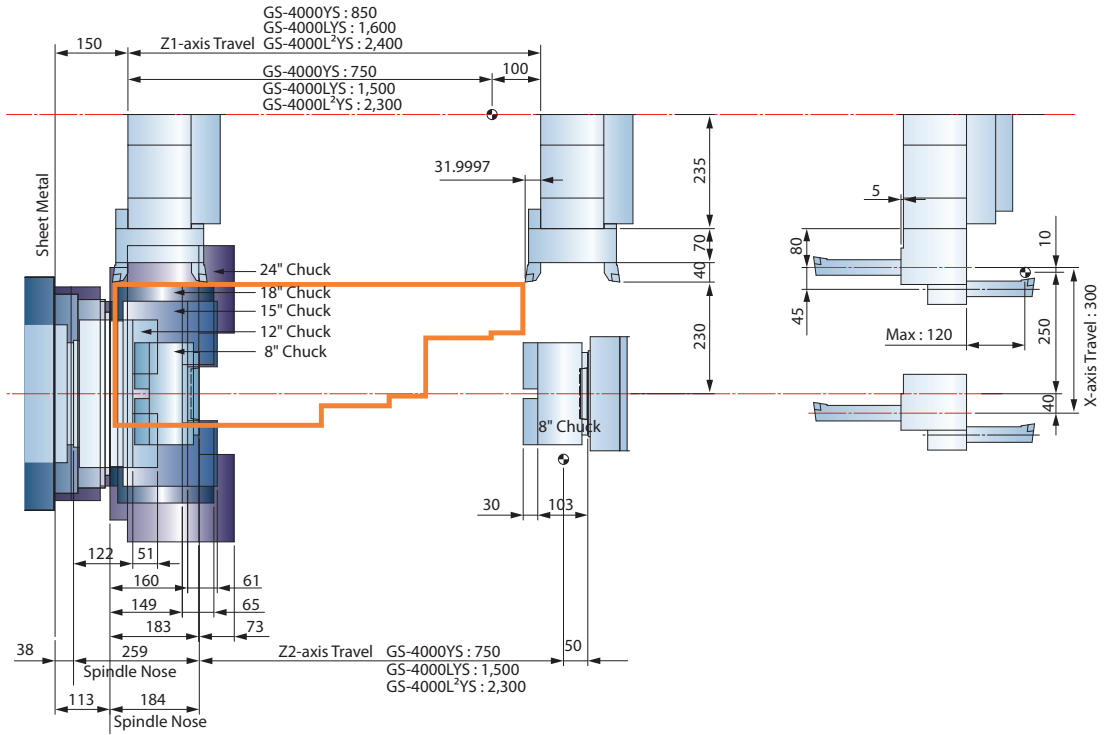

(Live Tooling)

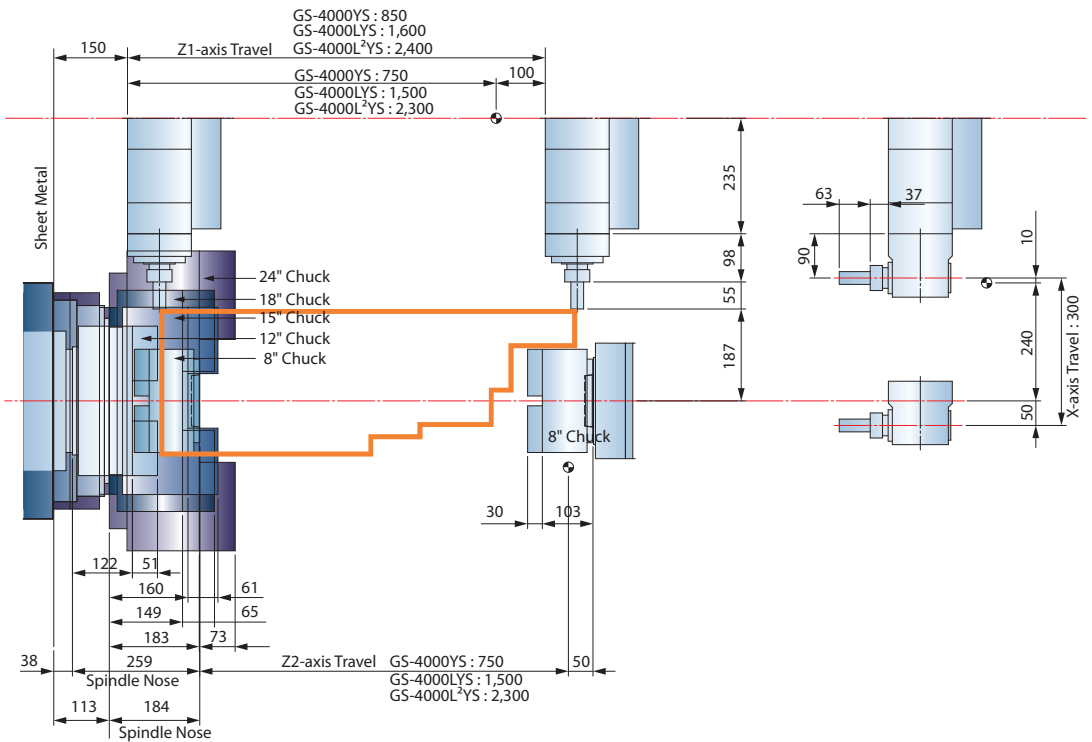

GENERAL DIMENSION

Space Requirement

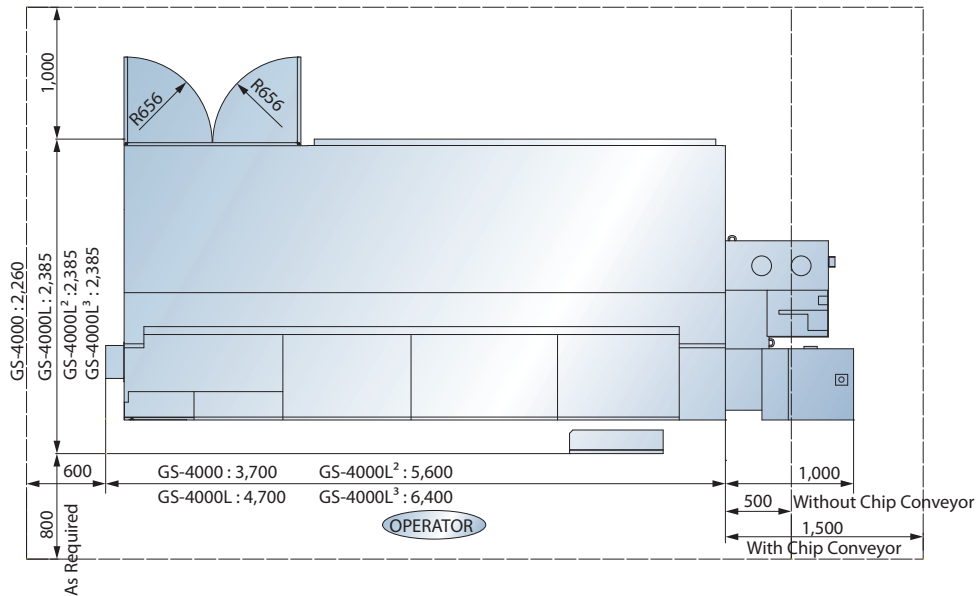

Machine Layout

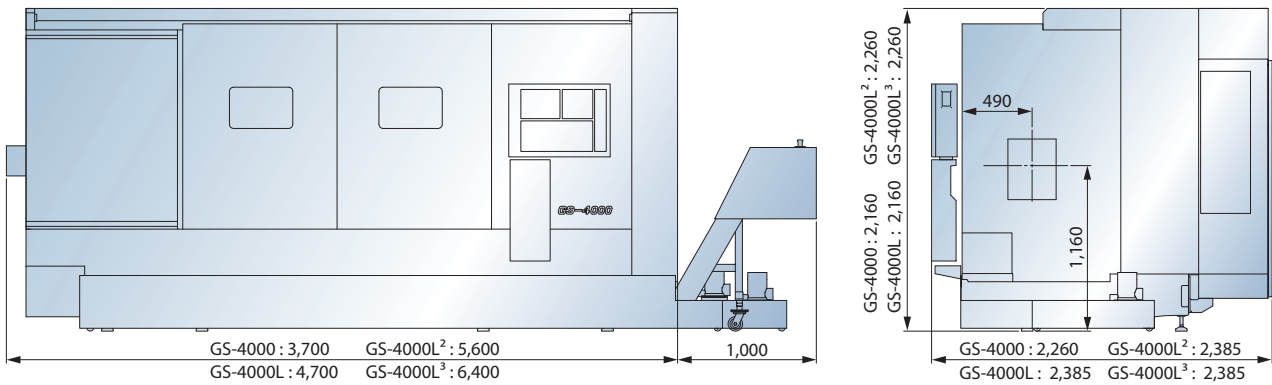

Unit : mm

Foundation Requirement

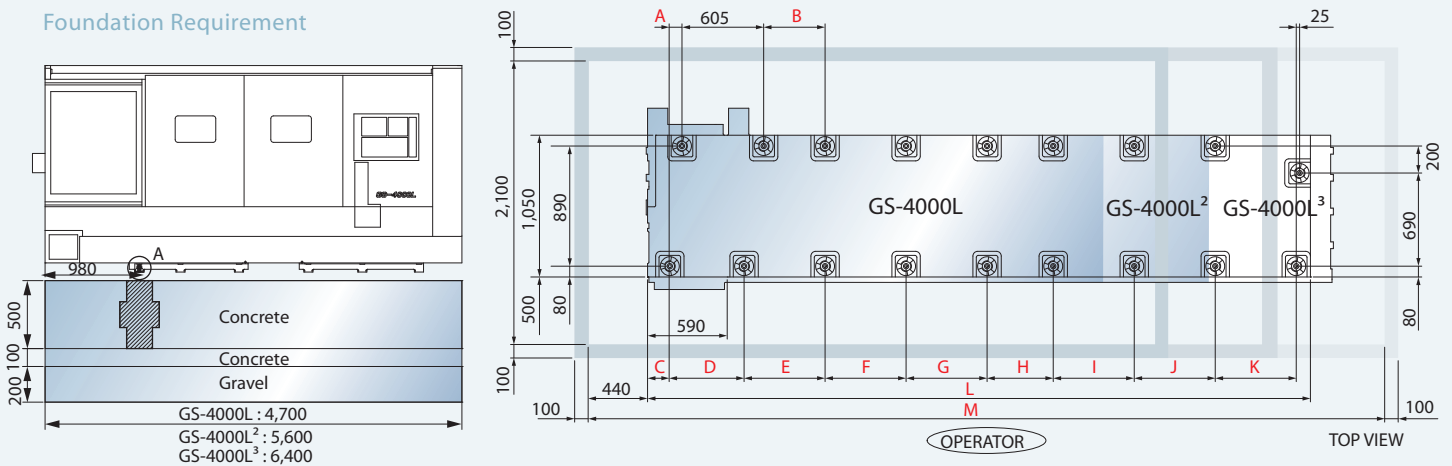

Unit : mm

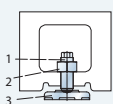

NO.	Part No	Part Name
1	CA-1029	Levelling Bolt
2	NA3900BA	Hex. Nut M39
3	CA-1030	Levelling Block

Model	A	B	C	D	E	F	G	H	I	J	K	L	M
GS-4000L	90	455	165	550	600	600	600	600	—	—	—	3,220	4,200
GS-4000L ²	90	505	165	600	600	647	647	646	600	—	—	4,010	5,000
GS-4000L ³	95	455	160	555	600	600	600	490	600	600	600	4,910	5,900

Y-axis models may vary, detail specification please contact with Goodway.

STANDARD FEATURES

Heat Exchanger

- ▶ The heat exchanger provides the electrical box with good air circulation to efficiently lower the interior temperature and stabilize the electrical devices.



3-Jaw Chuck w/ Soft Jaws x 1 set

- ▶ Standard 3-jaw hydraulic chuck with soft jaws is able to work with various types of work pieces.



Lubrication System

- ▶ The lubrication unit monitors preset pressure levels to detect leaks in the system.

- ▶ Copper lubrication lines will not corrode or become brittle over time.

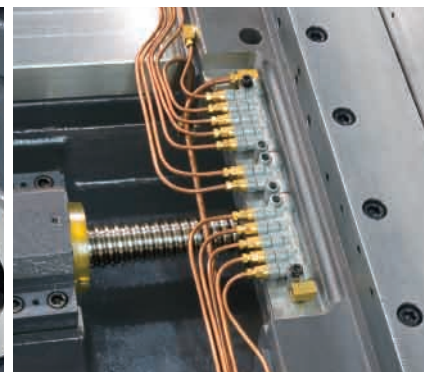
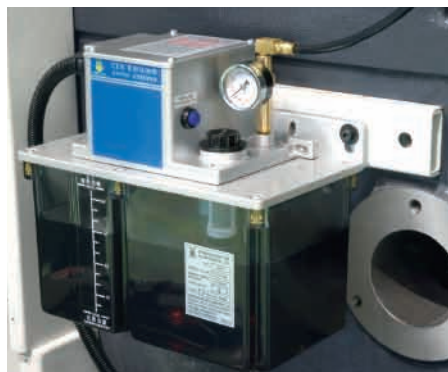

Tri-color Status Light

- ▶ Tri-color machine status light enables checking of machine's status without standing at the control panel or when the screen and work lights are shut off to conserve power.



Chip Conveyor

- ▶ The standard chip conveyor features adjustable timers that allow the operator to set operation intervals according to the amount of chips generated by the machine. Thus, reducing coolant loss to a minimum.

OPTIONAL FEATURES

Bar Feeder

- ▶ Optional bar feeding systems feed bars up to Ø105 mm diameter.

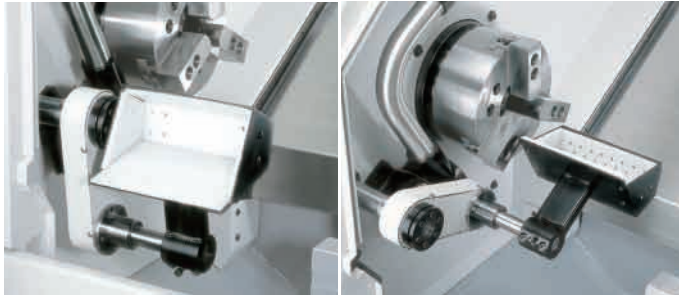

17

18

Parts Catcher

- ▶ Optional hydraulic parts catchers can be programmed to catch finished parts after cut-off.

Tool Setter

- ▶ The optional Renishaw HPMa tool setter utilizes a motorized arm to lower the tool probe into position. An auto tool check function further increases tool touch off efficiency.

(GS-4000 / GS-4300 series apply to HPRA manual tool setter.)

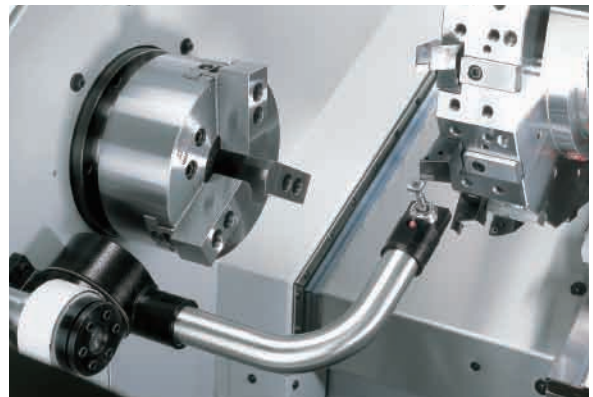

The steady rest is applied to long work pieces which can be firmly supported to increase turning accuracy.

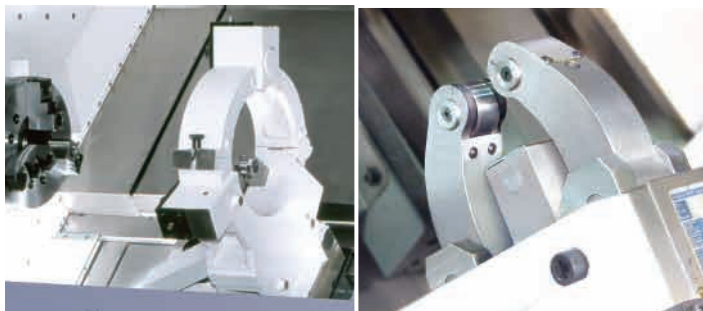

Manual Steady Rest

- ▶ It can be manually adjusted which requires less space than hydraulic steady rests.

Hydraulic Steady Rest

- ▶ The hydraulic pressure is controlled by the program to increase working efficiency.

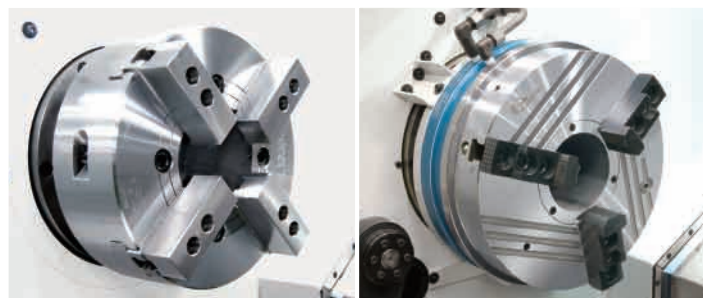

4-Jaw Chuck

- ▶ The 4-jaw chuck can work with complex-shaped or non-circular materials which cannot be done by 3-jaw chucks.

Air Chuck

- ▶ The air chuck can work with soft or thin materials to prevent from deforming rather than using a hydraulic chuck.

STANDARD & OPTIONAL FEATURES

S: Standard O: Optional
 -: Not Available C: Contact GOODWAY

		GS-4033	GS-4000	GS-4300
SPINDLE				
Main spindle motor configuration	2-Speed	S	-	-
	2-Speed Gear	O	S	S
Rigid tapping & spindle orientation		S	S	S
Disk brake for main		O	O	O
Cs-axis & disk brake for main spindle		O	O	O
Sub-spindle & 8" hydraulic cylinder*1		O	O	O
Cs-axis & disk brake for Sub-spindle*1		O	O	O
WORK HOLDING				
Hydraulic hollow cylinder for chuck	91 mm ID.	S	-	-
	118 mm ID.	O	S	S
	180 mm ID.	-	O	O
Hollow 3-jaws chuck & 1 set soft jaws	12"	S	-	-
	15"	-	S	-
	18"	-	O	-
	24"	-	-	S
	Hard jaws	O	O	O
Special work holding chuck		C	C	C
In spindle work stopper		O	O	O
Spindle liner (guide bushing)		O	O	O
Foot switch for chuck operation		S	S	S
Programmable base & quill hydraulic tailstock		S	S	S
MT#4 dead center*1 (servo tailstock)		O	O	O
MT#5 live center*1 (servo tailstock)		O	O	O
MT#6 live center		S	S	S
Manual steady rest		O	O	O
Self-centering hydraulic steady rest		O	O	O
Foot switch for steady rest operation		O	O	O
Two-stage programmable pressure	Chuck clamping	O	O	O
	Tailstock thrust	O	O	O
TURRET				
10-station turret		O	O	O
12-station turret		S	S	S
12-station live tooling turret		O	O	O
Tool holder & sleeve package		S	S	S
Live tooling tool holders		O	O	O
MEASUREMENT				
Renishaw HPRA tool presetter	Removeable	-	O	O
Renishaw HPMA tool presetter		O	-	-
COOLANT				
Coolant pump	3 Kg/cm ²	S	S	S
	5 Kg/cm ²	O	O	O
High-pressure coolant system		O	O	O
Roll-out coolant tank		S	S	S
Oil skimmer		O	O	O
Coolant flow switch		O	O	O
Coolant level switch		O	O	O
Coolant intercooler system		O	O	O
CHIP DISPOSAL				
Chip conveyor with auto timer	Right discharge	S	S	S
Chip cart with coolant drain		O	O	O
Chuck air blow		O	O	O
Tailstock air blow		O	O	O
Oil mist collector		O	O	O

*1 Not available on L³ series.

*2 Standard with tailstock option.

		GS-4033	GS-4000	GS-4300
AUTOMATIC OPERATION SUPPORT				
Parts catcher		O	O	O
Work piece transport conveyor		O	O	O
Bar feeder & interface		O	O	O
Gantry-type loader / unloader		O	O	O
Auto door		O	O	O
External M-code output	4 sets (8)	O	O	O
	8 sets (16)	O	O	O
SAFETY				
Fully enclosed guarding		S	S	S
Impact resistant viewing window		S	S	S
Tailstock stroke out - end check*2		S	S	S
Chuck cylinder stroke out - end check		S	S	S
Low hydraulic pressure detection switch		S	S	S
Load monitoring function		O	O	O
OTHERS				
Tri-color operation status light tower		S	S	S
External work light		O	O	O
Electrical cabinet	Heat exchanger	S	S	S
	A/C cooling system	O	O	O
Complete hydraulic system		S	S	S
Advanced auto lubrication system		S	S	S
Foundation leveling & maintenance tool kit		S	S	S
Emergency maintenance electrical part package		S	S	S
Operation & maintenance manuals		S	S	S
CONTROL				
Fanuc Oi-TD		S	S	S
Fanuc 18i-TB		O	O	O
FANUC CONTROL FUNCTIONS				
PMC system	OiD PMC : 0.025 μ sec/step	S	-	
	SB7: 0.033 μ sec/step	-	S	
Display	8.4" color LCD	S	-	
	10.4" color LCD	O	S	
Graphic function		S	S	
Full keypad	Small - 44 keys	S	-	
	Large - 56 keys	-	S	
Part program storage length	1,280m	S	S	
	2,560m	-	O	
Registerable programs	400	S	S	
	1,000	-	O	
Tool offset pairs	64	S	S	
	99	O	O	
	400	-	O	
	999	-	O	
Servo control		HRV2 (3)	S	S
Conversational programming	Manual Guide Oi	S	-	
	Manual Guide i	O	S	
	CAP i-T	-	O	
Servo motors		Alpha i	S	S
Spindle motors		Alpha i*3, iP*4	S	S

Specifications are subject to change without notice.

*3 For GS-4000 & GS-4300 series

*4 For GS-4033 series only

MACHINE SPECIFICATIONS

CAPACITY		GS-4033 / 4033L / 4033L ² / 4033L ³	GS-4000 / 4000L / 4000L ² / 4000L ³	GS-4300 / 4300L / 4300L ² / 4300L ³
Max. swing diameter		Ø 770 mm (30.31")		
Swing over saddle		Ø 940 mm (37.00")		
Max. turning diameter		Ø 620 (24.40")		
Std. turning diameter		Ø 268 mm (10.55")		
Max. turning length		819 / 1,569 / 2,369 / 3,169 mm (32.24" / 61.77" / 93.26" / 124.76") [15" Chuck]*1		
Chuck size		12"	15" (18")	24"
Bar capacity		Ø 90 mm (3.5")	Ø 115 mm (4.5")	Ø 165 mm (6.5")
SPINDLE				
Hole through draw tube		Ø 90.5 mm (3.56")	Ø 118 mm (4.64")	Ø 165.5 mm (6.51")
Hole through spindle		Ø 101 mm (3.97")	Ø 130 mm (5.11")	Ø 190 mm (7.48")
Spindle bearing diameter (Front / Rear)		Ø 140 / 120 mm (5.51" / 4.72")	Ø 180 / 160 mm (7.08" / 6.29")	Ø 240 / 220 mm (9.44" / 8.66")
Hydraulic cylinder		12"	15" (18")	24"
Spindle nose		A2-8	A2-11	A2-15
Spindle motor type		α P40 / 6,000i	α 30 / 6,000i	
Motor output (Con. / 30 min.)		18.5 / 22 Kw (25 / 30 HP)	30 / 37 Kw (40 / 50 HP)	
Motor full output speed		400 (Y) / 575 (Δ) RPM	1,150 RPM	
Spindle drive system		Belt drive motor	2-Speed Gear box	
Spindle drive ratio		1 : 2	1 : 3 / 1 : 6	1 : 5 / 1 : 10
Spindle speed ranges	L	8 ~ 750 rpm	10 ~ 1,000 rpm	6 ~ 600 rpm
	H	30 ~ 3,000 rpm	20 ~ 2,000 rpm	12 ~ 1,200 rpm
Spindle full output speed	L	200 rpm	196 rpm	121 rpm
	H	288 rpm	388 rpm	239 rpm
Spindle torque (Con. / 30 min.)	L	620 / 1,049 N-m	1,463 / 1,805 N-m	2,370 / 2,923 N-m
Spindle torque (Con. / 30 min.)	H	613 / 730 N-m	739 / 911 N-m	1,197 / 1,476 N-m
C-AXIS SPINDLE (OPTIONAL)				
Drive type		Cs		
Torque output		1,049 N-m	1,805 N-m	2,923 N-m
X & Z AXES				
Max. X-axis travel		350 mm (13.77")		
Max. Z1-axis travel		850 / 1,600 / 2,400 / 3,200 mm (33.46" / 62.99" / 94.48" / 125.98")		
Max. Z2-axis travel		800 / 1,550 / 2,350 / — mm (31.49" / 61.02" / 92.51" / —)		
X-axis rapids		24 m/min. (945 IPM)		
Z1-axis rapids		24 / 24 / 16 / 12 m/min. (945 / 945 / 630 / 473 IPM)		
Z2-axis rapids		24 / 24 / 16 / — m/min. (945 / 945 / 630 / — IPM)		
Slide way type		Hardened & Ground Box Ways		
Feed rates		1 ~ 4,800 mm/min. (1 ~ 189 IPM)		
X-axis servo motor		α 30 / 3,000i		
Z1-axis servo motor		α 30 / 3,000i		
Z2-axis servo motor		α 12 / 3,000i		
X-axis ball screw Ø [pitch]		Ø 36 mm [pitch 10]		
Z1-axis ball screw Ø [pitch]		Ø 45 mm [pitch 10] / Ø 45 mm [pitch 10] / Ø 63 mm [pitch 10] / Ø 63 mm [pitch 16]		
Z2-axis ball screw Ø [pitch]		Ø 36 mm [pitch 10] / Ø 40 mm [pitch 10] / Ø 50 mm [pitch 12] / —		
X-axis thrust (Con.)		1,921 Kgf (4,226 lbs)		
Z1-axis thrust (Con.)		1,921 / 1,921 / 1,921 / 1,201 Kgf (4,226 / 4,226 / 4,226 / 2,642 lbs)		
Z2-axis thrust (Con.)		769 / 769 / 641 / — Kgf (1,692 / 1,692 / 1,410 / — lbs)		

Specifications are subject to change without notice.

*1 Individual models may vary, detail specification please see work range diagram or contact with Goodway.

MACHINE SPECIFICATIONS

TURRET	GS-4033 / 4033L / 4033L ² / 4033L ³	GS-4000 / 4000L / 4000L ² / 4000L ³	GS-4300 / 4300L / 4300L ² / 4300L ³
Stations	12		
Indexing drive	β 8 / 3,000 i s		
Indexing speed	0.3 sec. Adjacent / 0.8 sec. (Single step)		
Accuracy	Positioning : \pm 0.00069°, Repeatability : \pm 0.00027°		
OD tool shank size	<input type="checkbox"/> 32 mm (1-1/4")		
ID tool shank size	\varnothing 60 mm (2-1/4")		
LIVE TOOLING TURRET (OPTIONAL)			
Max. turning diameter	\varnothing 550 mm (21.65")		
Std. turning diameter	\varnothing 305 mm (12.00")		
Max. turning length	695 / 1,445 / 2,245 / 3,045 mm (27.36" / 56.88" / 88.38" / 119.88") [15" Chuck]*1		
Stations	12		
Live tooling stations	12		
Live tooling drive motor	5.5 / 7.5 Kw (α 6 / 10,000 i , Deceleration 1 : 2) [Y-axis : 3.7 / 5.5 Kw built-in motor]		
Indexing drive type	β 12 / 3,000 i s		
Index speed	0.3 sec. Adjacent / 0.8 sec. (Single step)		
OD tool shank size	<input type="checkbox"/> 25 mm (1")		
ID tool shank size	\varnothing 50 mm (2")		
Live tooling shank size	\varnothing 26 mm (1") ER 40		
Live tooling RPM range	4,000 RPM [Y-axis : 6,000RPM]		
Y-AXIS (OPTIONAL)			
Max. swing diameter	\varnothing 700 mm (27.55")		
Swing over saddle	\varnothing 900 mm (35.43")		
Max. turning diameter	\varnothing 460 mm (18.11")		
Max. turning length	634 mm / 1,384 mm / 2,184 mm / 2,984 mm (24.96" / 54.48" / 85.98" / 117.48") [15" Chuck]		
Max. X-axis travel	300 mm (11.81")		
Max. Y-axis travel	120 mm = \pm 60 mm (4.72" = \pm 2.36")		
X / Y axes rapids	24 / 10 m/min. (945 / 393 IPM)		
Slide way type	Hardened & Ground Box Ways		
Feed rates	1 ~ 4,800 mm/min. (1 ~ 189 IPM)		
X-axis servo motor	AC 7 Kw (9.5 HP, Fanuc α 30B/3,000 i , Absolute encoder, 1,000,000 / rev.)		
Y-axis servo motor	AC 3 Kw (4 HP, Fanuc α 22B/3,000 i , Absolute encoder, 1,000,000 / rev.)		
X-axis ball screw \varnothing / pitch	\varnothing 36 mm (1.41") / Pitch 10		
Y-axis ball screw \varnothing / pitch	\varnothing 36 mm (1.41") / Pitch 8		
X / Y axes thrust (Con.)	1,923 / 1,761 Kgf (4,230 lbs. / 3,874 lbs.)		
TAILSTOCK			
Quill center taper	MT#4 (Built-in type dead center , Servo tailstock)*2		
	MT#5 (Live center , Servo tailstock)*2		
	MT#6 (Live center , Programmable tailstock)		
Quill diameter	MT#4 : \varnothing 110 mm (4.33") / MT#5 : — / MT#6 : \varnothing 120 mm (4.72")		
Quill travel	MT#4 : — / MT#5 : — / MT#6 : 150 mm (5.90")		
Tailstock base travel	GS-4000 : 800 mm (31.5") (Servo tailstock) / 650 mm (25.6") (Quill programmable tailstock)*2		
	GS-4000L : 1,550 mm (61") (Servo tailstock) / 1,400 mm (55.1") (Quill programmable tailstock)*2		
	GS-4000L ² : 2,350 mm (92.5") (Servo tailstock) / 2,200 mm (86.6") (Quill programmable tailstock)*2		
	GS-4000L ³ : 3,000 mm (118.1") (Quill programmable tailstock)		
Programmable quill / base	MT#4 : — / Yes / MT#5 : — / Yes / MT#6 : Yes / Yes		

Specifications are subject to change without notice.

*1 Individual models may vary, detail specification please see work range diagram or contact with Goodway.

*2 Option

SUB-SPINDLE (OPTIONAL)* ³	GS-4033 / 4033L / 4033L² / 4033L³	GS-4000 / 4000L / 4000L² / 4000L³	GS-4300 / 4300L / 4300L² / 4300L³
Chuck size	8"		
Hole through spindle	Ø 55 mm (2.16")		
Spindle bearing diameter	Front : Ø 100 mm (3.93") / Rear : 70 mm (2.75")		
Spindle nose	A2-6		
Spindle motor type	18 / 21 Kw [24 / 28 HP (Bil112L / 15,000)]		
Motor output (Con.)	18.5 Kw (25 HP)		
Motor output (15 min.)	22 Kw (30 HP)		
Motor full output speed	5,000 RPM		
Spindle drive system	Direct built-in motor (Integrated Motor)		
Spindle drive ratio	1 : 1		
Spindle speed range	4,800 RPM		
Spindle torque (Con.)	50 N-m (36 ft-lbs)		
Spindle torque (15 min.)	60 N-m (42 ft-lbs)		
B-axis travel	800 / 1,550 / 2,350 mm (31.5" / 61" / 92.5")		
B-axis rapid	24 / 24 / 16 / — m/min. (945 / 945 / 630 / — IPM)		
Slide way type	Hardened & Ground Box Ways		
B-axis servo motor	AC 3.0 Kw (4.1 HP, Fanuc α 12 / 3,000i , Absolute encoder, 1,000,000 / rev.)		
B-axis ball screw Ø [pitch]	Ø 36 mm [Pitch 10] / Ø 40 mm [Pitch 10] / Ø 50 mm [Pitch 12]		
B-axis thrust (Con.)	769 / 769 / 640 / — Kgf (1,692 / 1,692 / 1,408 / — lbs.)		
GENERAL			
Positioning accuracy	± 0.005 mm (± 0.0002")		
Repeatability	± 0.003 mm (± 0.0001")		
Standard CNC control	FANUC Oi-TD (18i-TB Opt.)		
Voltage / Power requirement	AC 200/220 + 10% to - 15% 3 phase / 65 KVA		
Hydraulic tank capacity	45 L (11.8 gal)		
Coolant tank capacity	330 / 410 / 540 / 670 L (87 / 108 / 143 / 177 gal.)		
Coolant pump	0.7 Kw (60 Hz) rated at 3 bar (44 PSI)		
Machine weight	8,000 / 11,000 / 13,500 / 16,000 Kg (17,637 / 24,251 / 29,762 / 35,274 lbs.)		
Dimensions L × W × H	3,700 × 2,260 × 2,120 mm (146" x 89" x 84")		
	L : 4,700 × 2,385 × 2,120 mm (185" x 94" x 84")		
	L ² : 5,600 × 2,385 × 2,260 mm (221" x 94" x 89")		
	L ³ : 6,400 × 2,385 × 2,260 mm (252" x 94" x 89")		

Specifications are subject to change without notice.

*3 Not available on L³ series.



GOODWAY MACHINE CORP.

Headquarters :

No.13, 5Th Road,
Taichung Industrial Park,
Taichung City, 407, Taiwan, R.O.C.
TEL : + 886-4-2359-1226
Website : www.goodwaycnc.com
E-mail : goodway@goodwaycnc.com

GOODWAY (SUZHOU) MACHINE CORP.

No.589, Chengyang Road,
Xiang Cheng Economic Development District
Suzhou City, Jiangsu, China
TEL : + 86-512-6576-3699
TEL : + 86-512-6576-7299
Website : www.goodwaycnc.com.cn
E-mail : goodway.suzhou@goodwaycnc.com.tw

Central Taiwan Science Park Branch :

No. 38, Keyuan Road,
Central Taiwan Science Park.Taichung,
Taichung City, 407, Taiwan, R.O.C.
TEL : + 886-4-2463-6000
TEL : + 886-4-2463-9600